

Muncie PTO brought to you by Pro Gear & Transmission

REBUILT MUNCIE PTO

877-776-4600 | 407-872-1901

**Pro Gear**  
AND TRANSMISSION

For Muncie PTO parts or service call Pro Gear & Transmission, Inc.  
877-776-4600 / 407-872-1901 | [parts@eprogear.com](mailto:parts@eprogear.com)

# EXTENDED SHAFT INSTALLATION

*For use of CD10, CS10, CS20 and CS41 Series Muncie PTOs  
with Allison 3000 and 4000 Series World Transmissions*

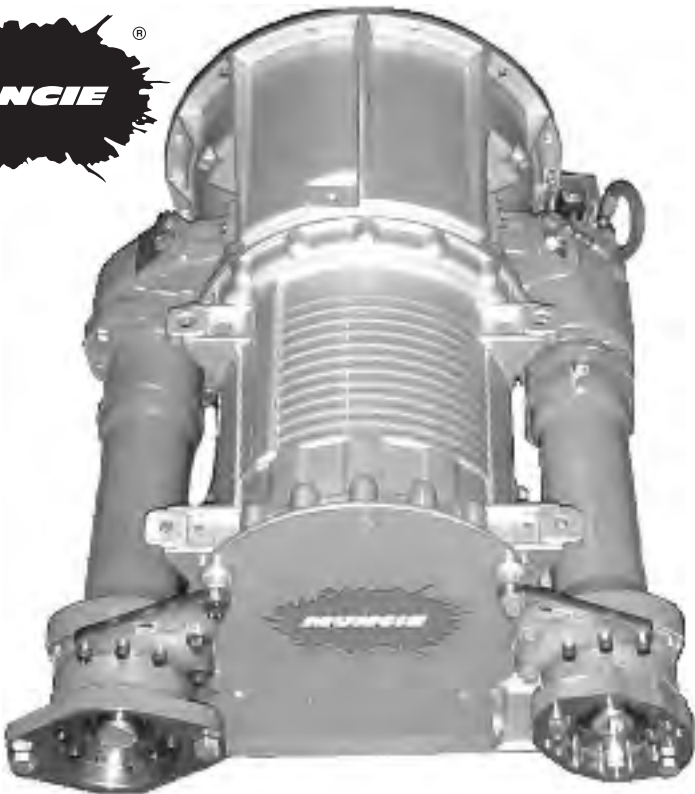

# EXTENDED SHAFT INSTALLATION

## FOR ALLISON 3000 OR 4000 SERIES TRANSMISSIONS

Muncie's Extended Shaft is designed for Allison Automatic transmissions 3000 or 4000 series only. Kits are available for the 3000 Right-side and Left-side openings and for the 4000 Left-side only.

**Exceptions:** The extended shaft is not currently available for retarder version transmissions or units with rear-mounted transmission oil coolers.

Not currently available for the 7-speed HD4070 transmission.

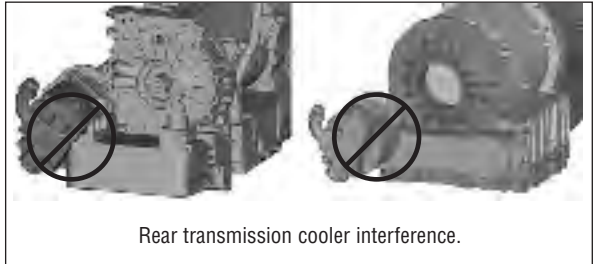

**Important:** Transmissions must have rear support installed as supplied by the vehicle manufacturer.

---

You must know what PTO model and Extended Shaft model you have. Open the carton of each and examine the contents and locate the supplemental instruction sheet for important installation instructions.

**CD10-A10\*\*-M1ZX** *Right Side 3000 Series Kits:*  
49TA4133A, 49TA4134A, 49TA4135A, 49TA4137A, 49TA4451A & 49TA5000A  
I-40923 Instruction Sheet

**CD10-A10\*\*-M3ZX** *Left Side 3000 Series Kits:*  
49TA4125A, 49TA4126A, 49TA4127A, 49TA4128A, 49TA4450A & 49TA4999A  
I-40922 Instruction Sheet

**CD10-A10\*\*-M3ZX** *Left Side 4000 Series Kits:*  
49TA4129A, 49TA4130A, 49TA4131A, 49TA4132A, 49TA4432A & 49TA4941A  
I-40921 Instruction Sheet

---

**CS20-A10\*\*-H1IX** *Right Side 3000 Series Kits:*  
49TA4694A, 49TA4699A, 49TA4789A, 49TA4839A, 49TA4897A & 49TA5002A  
I-40929 Instruction Sheet

**CS20-A10\*\*-H3IX** *Left Side 3000 Series Kits:*  
49TA4692A, 49TA4698A, 49TA4788A, 49TA4838A, 49TA4896A & 49TA5001A  
I-40926 Instruction Sheet

**CS20-A10\*\*-H3IX** *Left Side 3000 Series with TOP Opening Kits:*  
49TA4841A  
I-40929 Instruction Sheet

**CS20-A10\*\*-H3IX** *Left Side 4000 Series Kits:*  
49TA4833A, 49TA4834A, 49TA4835A, 49TA4840A, 49TA4875A, 49TA4898A & 49TA5003A  
I-40925 Instruction Sheet

---

**CS10-A10\*\*-H3ZX** *Left Side 3000 Series Kits:*  
49TA4495A, 49TA4506A & 49TA4837A  
I-40924 Instruction Sheet

---

**CS41-A10\*\*-H3ZX** *Left Side 4000 Series Kits:*  
49TA4877A, 49TA4880A, 49TA4881A & 49TA5004A  
I-40931 Instruction Sheet

1. Install Muncie series CD10, CS10 or CS20 PTO following the instruction manual provided with the PTO, IN95-02. **Fig 1**
2. Check the mounting flange orientation against the supplemental instruction sheet included with your kit. If needed, rotate the PTO flange to match.

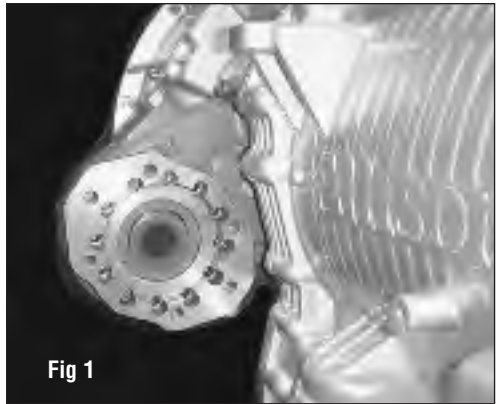

3. Remove the three transmission capscrews (4 on CS10 kits) from the rear of the Allison transmission where the extended shaft bracket is to mount. **Fig 3**
4. Remove the extended shaft from the carton. The extended shaft should have the transmission mounting bracket attached to the unit. Review the extended shaft supplemental instruction sheet (enclosed with extended shaft) for proper position of the transmission bracket and extended shaft flange (PTO end). If they are not properly installed, the extended shaft will not align properly. Make changes if necessary.

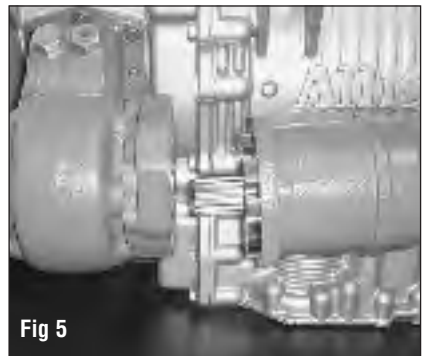
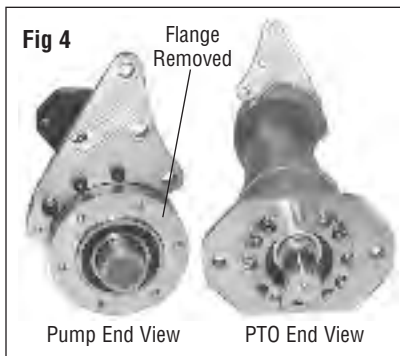
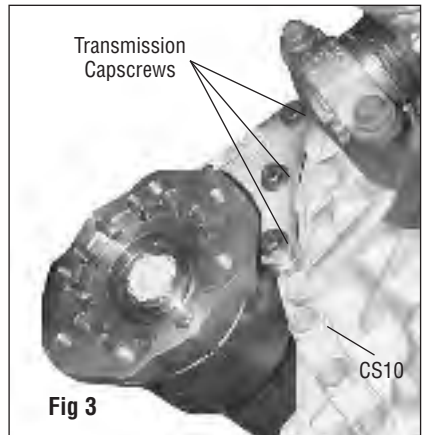

Remove the hydraulic flange (pump end view) from the extended shaft for ease of installation. Set the flange and capscrews aside for re-use. **Fig 4**

5. Remove the cap plug from the end of the PTO output shaft and make sure splines are greased. PTOs are supplied with appropriate grease from factory. If dry apply an anti-fretting compound to the splines. Insert the male spline from extended shaft into PTO spline and mate with PTO pilot on flange. **Fig 5**

- 6.** Using the supplied capscrews from kit insert one into the mounting bracket and turn several threads into the transmission case. This will align the bracket with the other two holes. Should you find that the 3 capscrews will not align with the transmission holes, then you may need to rotate the extended shaft PTO side mounting flange (refer to appendix B, if needed). **Fig 6**

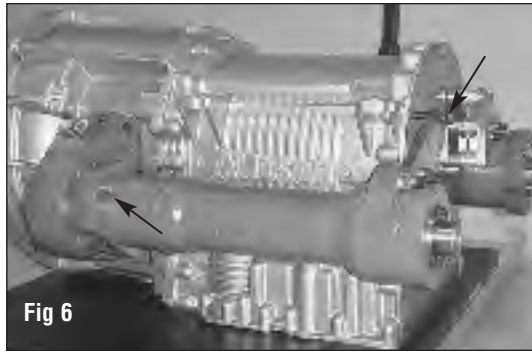

Insert the two extended shaft mounting capscrews and lock washers into the flange at the PTO, but do not tighten.

- 7.** The 3000 series transmission will require the use of spacers (#14) provided in the kit, the 4000 series transmissions do not require this spacer.

Insert transmission mounting capscrews (#15) through the bracket (and through the spacer if an 3000 application) and continue until all three capscrews have been installed.

**Fig 7**

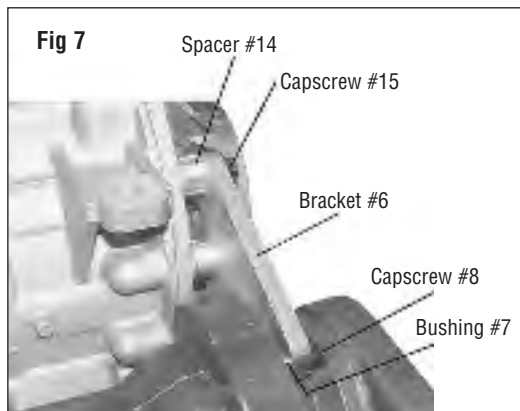

- 8.** The assembly should look similar to the photo. **Fig 8**

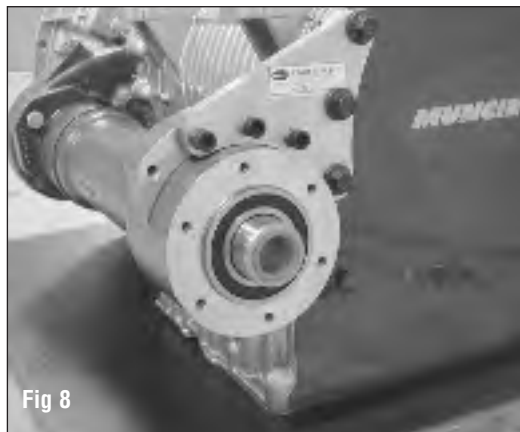

- 9.** Torque the PTO flange capscrews to 35 ft.lbs. **Fig 9**

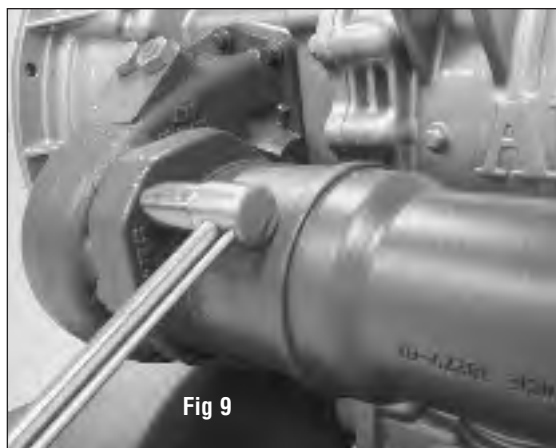

- 10.** Torque the transmission bracket capscrews to 68 ft.lbs. **Fig 10**



- 11.** Position and install the Hydraulic Pump mounting flange with the six capscrews removed in step 3 and torque to 25 ft.lbs. **Fig 11**



- 12.** Remove the cap plug from the end of the PTO output shaft and make sure splines are greased. PTOs are supplied with appropriate grease from factory. If dry apply an anti-fretting compound to splines. Installation of the extended shaft is complete. **Fig 12**

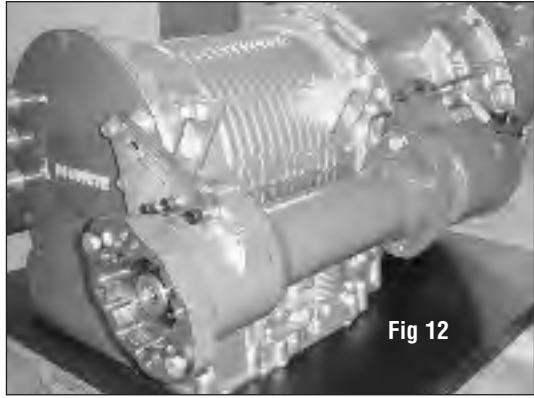

- 13.** Install the hydraulic pump making sure that all hydraulic lines are clear of rotating components on the vehicle. **Fig 13**



- 14.** Refer to PTO Owner's Manual (IN95-02) for general maintenance recommendations.

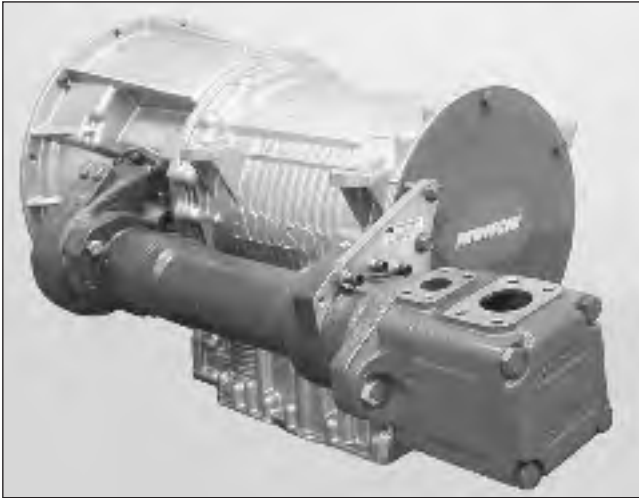

## APPENDIX

The mounting bracket is held in place with three socket head capscrews, but the bracket is free to move over the bushings installed into the bracket at assembly. The photos at right show the bracket assembly.



Torque capscrews  
to 32 ft.lbs.



**Muncie®  
Power  
Products**



**Muncie Power Products, Inc.** Member of the Interpump Hydraulics Group  
General Offices and Distribution Center • P.O. Box 548 • Muncie, IN 47308-0548 • (765) 284-7721  
FAX (765) 284-6991 • E-mail [info@munciepower.com](mailto:info@munciepower.com) • Web site <http://www.munciepower.com>  
Drive Products, Exclusive Agents for Canada, ISO Certified by an Accredited Registrar



# **Pro** **Gear**

***AND TRANSMISSION, INC.***

If you have any questions about any Munice Product, do not hesitate to call us so we can help you with finding the right PTO, part or anything else you may need.

906 West Gore St  
Orlando, FL 32805  
USA

Contact Us:

1-866-776-4600

1-407-872-1901

Fax:

1-407-872-6235